

- D** Montage und Betriebsanleitung
- GB USA** Assembly and Operating Instructions
- F** Instructions de montage et d'utilisation
- E** Instrucciones de uso y montaje
- P** Instruções de montagem e modo de utilização
- I** Istruzioni di montaggio e d'uso



- PL** Instrukcja obsługi i montażu
- NL** Montage- en gebruiksaanwijzing
- S** Monterings- och bruksanvisning
- FIN** Asennus- ja käyttöohjeet
- H** Összeszerelési és használati útmutató
- GR** Οδηγίες συναρμολόγησης και λειτουργίας

**TOURING STARS**

Stadlbauer Marketing + Vertrieb GmbH · Rennbahn Allee 1 · 5412 Puch / Salzburg · Austria · carrera-toys.com · carreraclub.com

**62268**

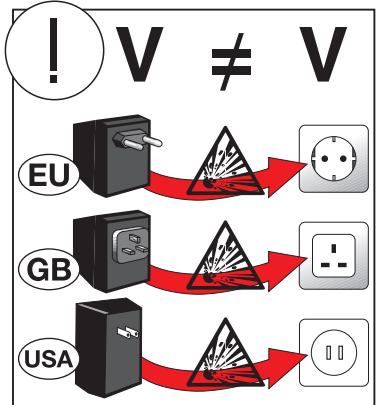
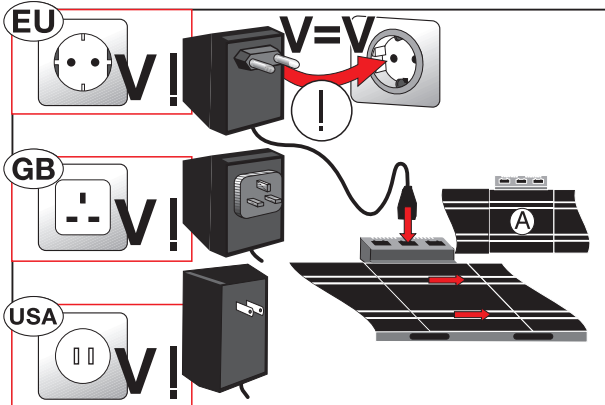
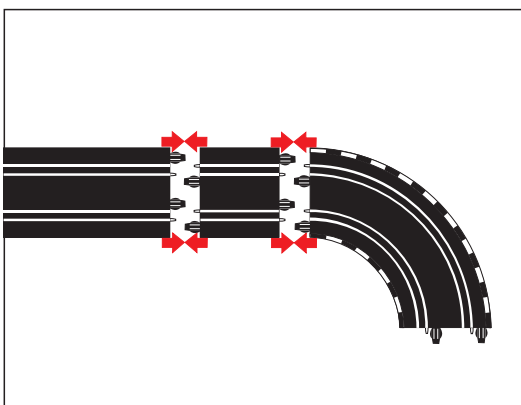
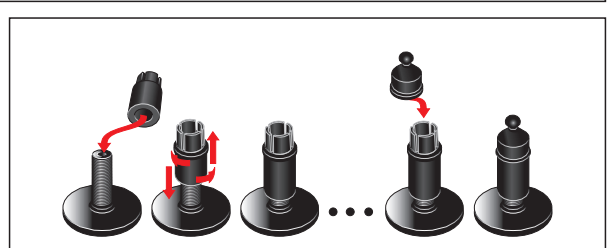
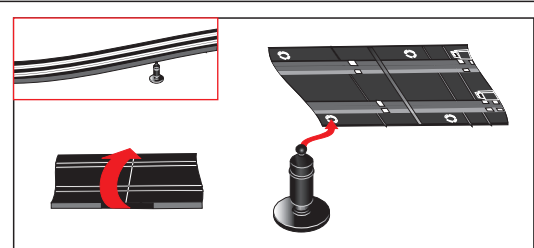
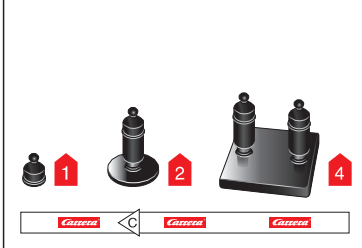
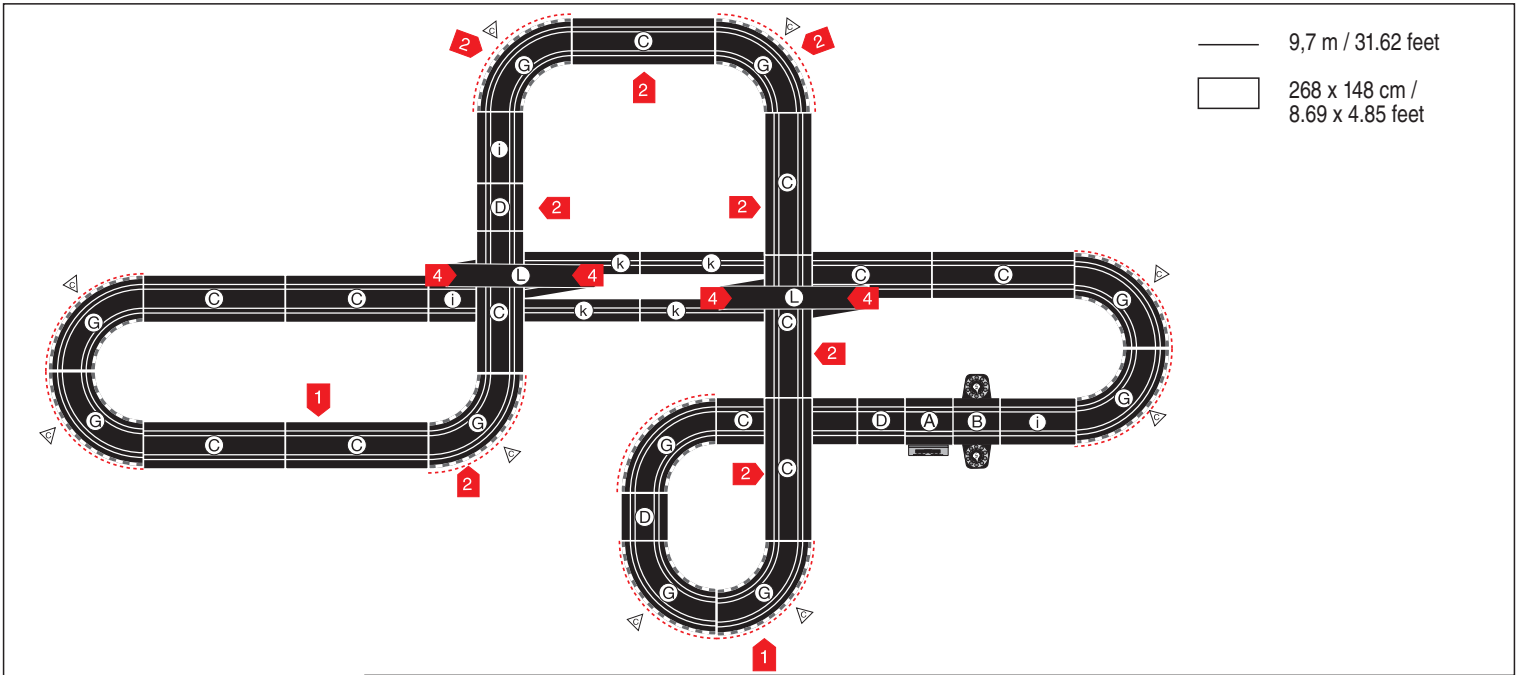
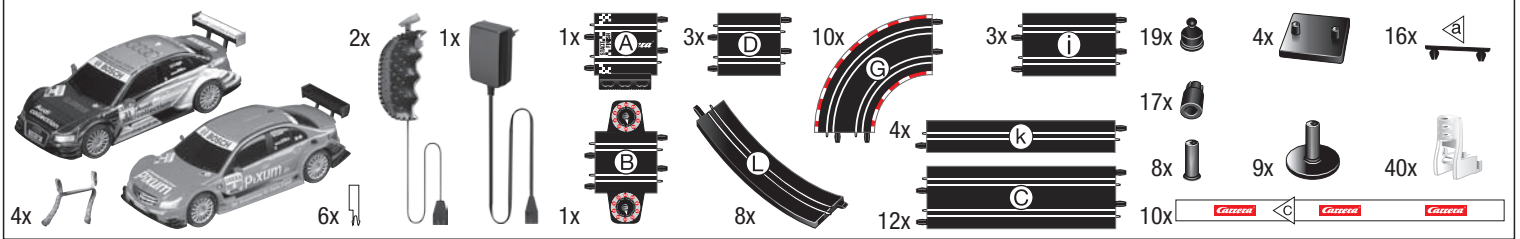

7.60.12.196.00

<p><b>D</b> Technische und designbedingte Änderungen vorbehalten.</p> <p><b>GB USA</b> Subject to technical and design-related changes.</p> <p><b>F</b> Sous réserve de modifications techniques ou de design.</p>	<p><b>E</b> Se reserva el derecho de efectuar modificaciones técnicas y relacionadas con el diseño.</p> <p><b>P</b> Reservados os direitos de alterações técnicas e no design.</p> <p><b>I</b> Con riserva di modifiche tecniche e di design.</p>	<p><b>PL</b> Zastrzegamy sobie możliwość zmian.</p> <p><b>NL</b> Technische en designgeboden afwijkingen voorbehouden.</p> <p><b>S</b> Med reservation för tekniska och designrelaterade ändringar.</p>	<p><b>FIN</b> Oikeus tekniikan ja muotoilun aiheuttamiin muutoksiin pidetään.</p> <p><b>H</b> Műszaki és konstrukciós változások előfordulhatnak.</p> <p><b>GR</b> Επιφύλαξη τεχνικών - σχεδιαστικών τροποποιήσεων.</p>
--	---	---	---

**WARNING:**  
CHOKING HAZARD - SMALL PARTS  
NOT FOR CHILDREN UNDER 3 YEARS.

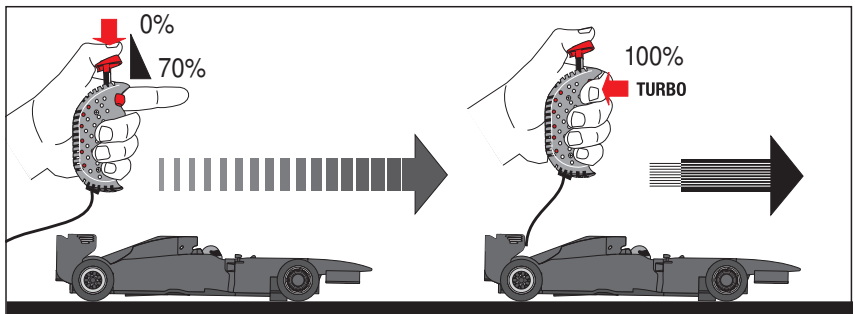
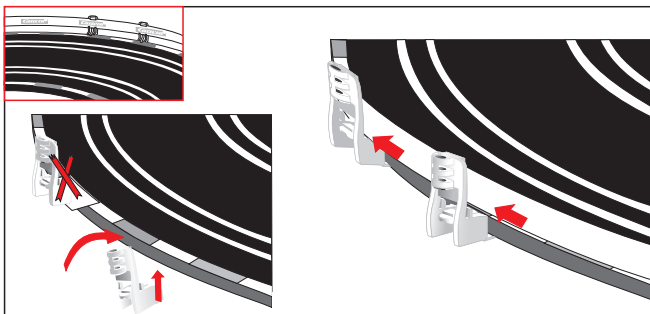
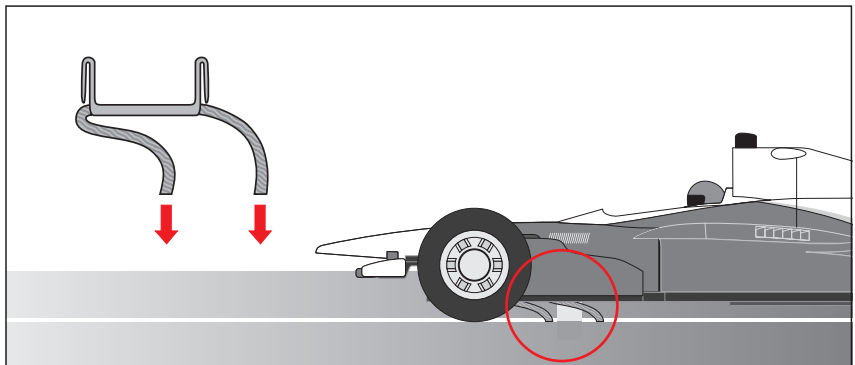
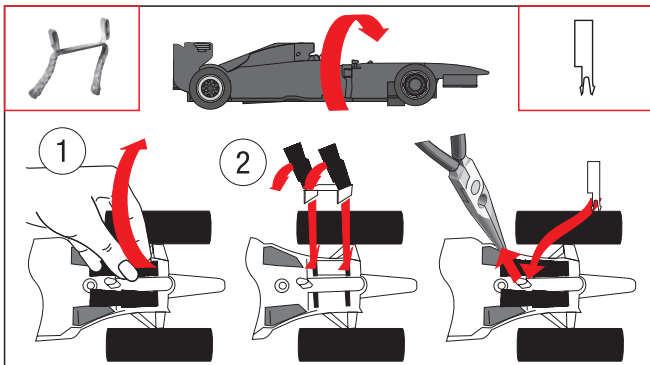
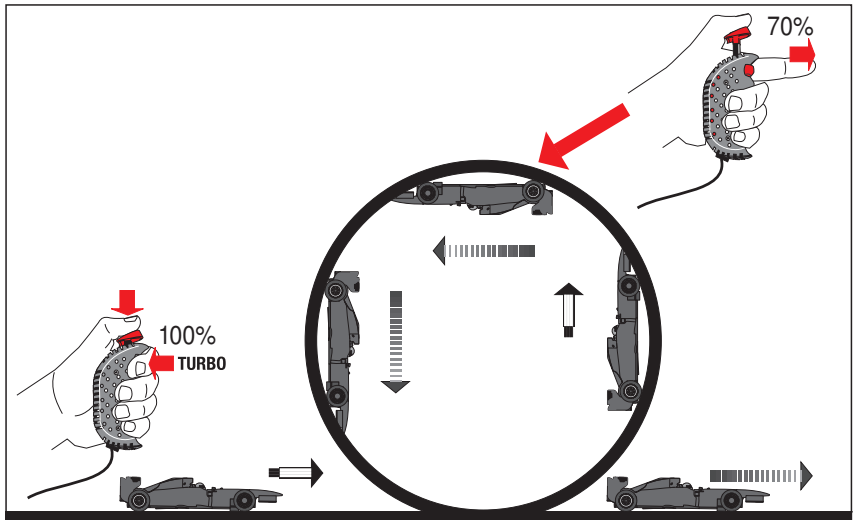
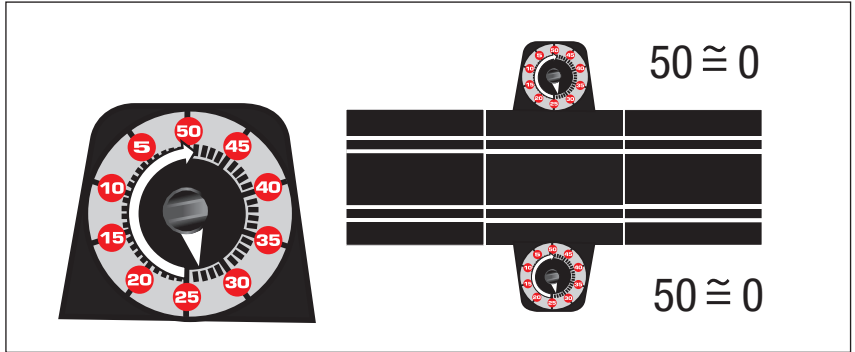
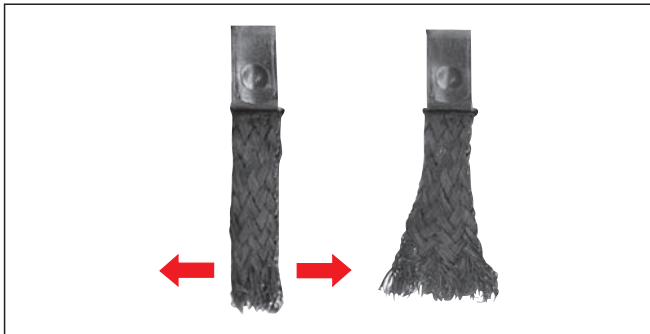
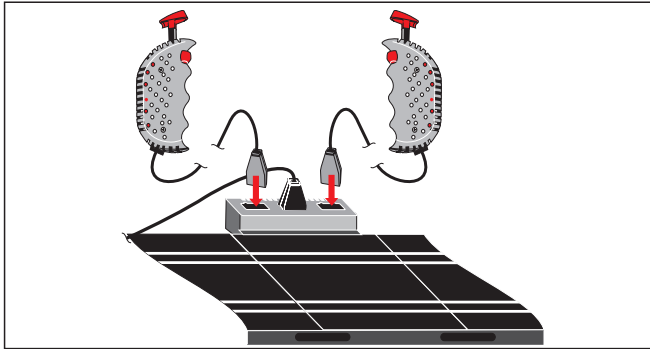
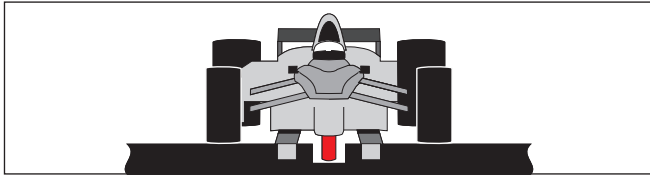
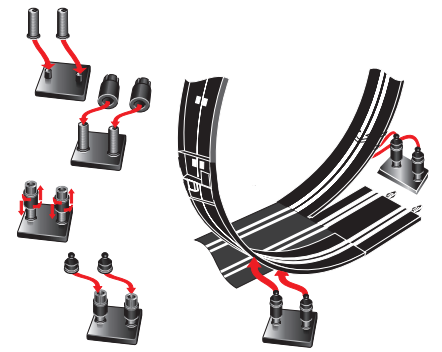
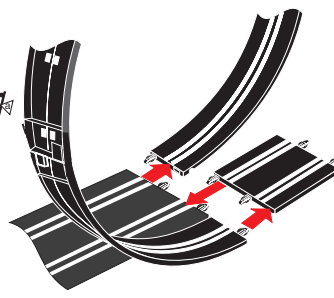
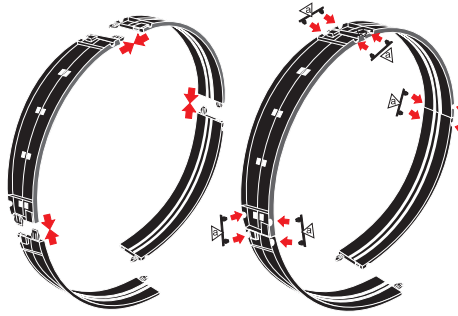
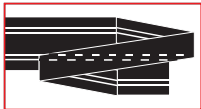

**D WICHTIG!** Deko-Elemente und Carrera Fahrzeuge werden als Symbol-Abbildungen dargestellt. Nur zum Zweck der Anleitung. Verpackungsinhalt siehe Stückliste. **- GB/USA IMPORTANT!** Décor elements and Carrera vehicles are presented as symbolic illustrations, purely for the purposes of the instructions. For package contents see parts list. **- F IMPORTANT!** Les éléments de décoration et les véhicules Carrera sont représentés sous forme de figures symboliques, uniquement à des fins d'instruction. Pour le contenu de l'emballage, voir la liste de pièces. **- E ¡IMPORTANTE!** Los elementos decorativos y los vehículos Carrera se muestran en imágenes con símbolo. Solo para servir a las instrucciones. Véase lista de piezas del contenido del paquete. **- P IMPORTANTE!** Os elementos de decoração e os carros Carrera são representados em forma de símbolos. Apenas para efeitos informativos. Ver o conteúdo da embalagem na lista de peças. **- I Importante!** Elementi decorativi e vetture Carrera vengono raffigurati come illustrazioni simboliche. Solo a scopo indicativo. Contenuto della confezione vedi elenco dei pezzi. **- PL WAŻNE!** Elementy dekoracyjne i pojazdy Carrera zostały przedstawione w formie symboli. Wyłącznie jako wskazówka. Zawartość opakowania - patrz wykaz części. **- NL BELANGRIJK!** Decoratie-elementen en Carrera-voertuigen worden als symbolen afgebeeld, slechts ter illustratie van de handleiding. De verpakking inhoud vindt u op de stuklijst. **- S VIKTIG!** Dekorelement och Carrera-fordon visas som symboler. Endast i informations syfte. Förpackningsinnehåll se stycklistan. **- FIN TÄRKEÄ!** Deko-elementit ja Carrera-ajoneuvot esitellään symboli-kuvina. Vain ohjetta varten. Pakkauksen sisältö, katso osaluetteloa. **- HUN FONTOS!** A dekorációs elemek és a Carrera járművek szimbólumábraként kerülnek ábrázolásra. Csúpan a leírás céljára. A csomagolás tartalmát lásd a darabjegyzékben. **- GR ΣΗΜΑΝΤΙΚΟ!** Διακοσμητικά στοιχεία και τα οχήματα Carrera παρουσιάζονται με συμβολικές απεικονίσεις. Μόνο στις οδηγίες. Περιεχόμενο συσκευασίας βλ. λίστα τεμαχίων.