

- D** Montage und Betriebsanleitung
- GB USA** Assembly and Operating Instructions
- F** Instructions de montage et d'utilisation
- E** Instrucciones de uso y montaje
- P** Instruções de montagem e modo de utilização
- I** Istruzioni di montaggio e d'uso



- PL** Instrukcja obsługi i montażu
- NL** Montage- en gebruiksaanwijzing
- S** Monterings- och bruksanvisning
- FIN** Asennus- ja käyttöohjeet
- HUN** Összeszerelési és használati útmutató
- GR** Μοντάζ και Οδηγία χρήσης

STOCK CAR DUELL

Stadlbauer Marketing + Vertrieb Ges.m.b.H. · Magazinstraße 4 · 5027 Salzburg · Austria · www.carrera-toys.com · www.carreraclub.com

62139

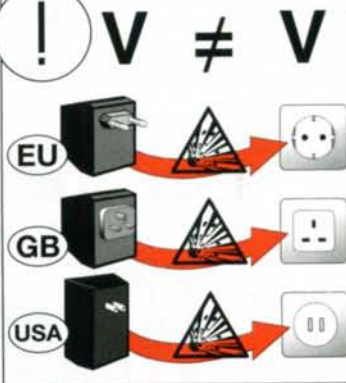
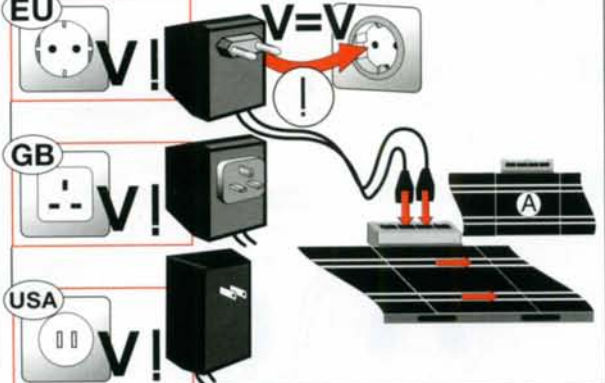
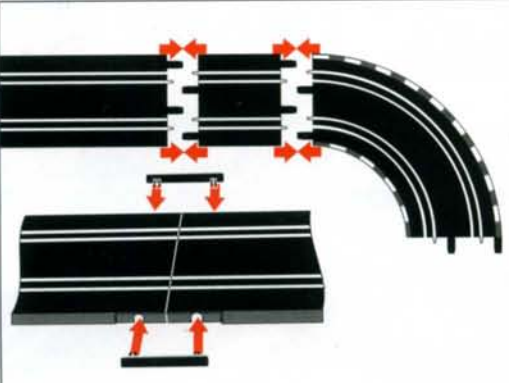
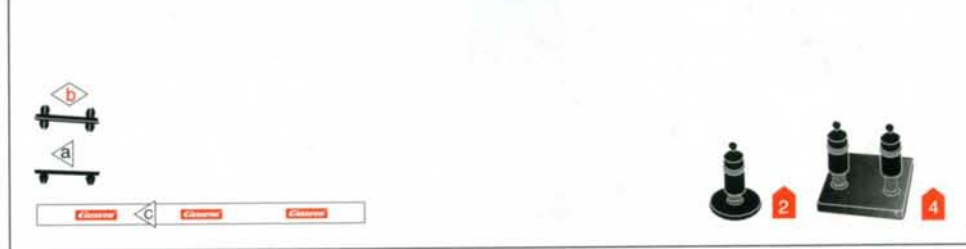
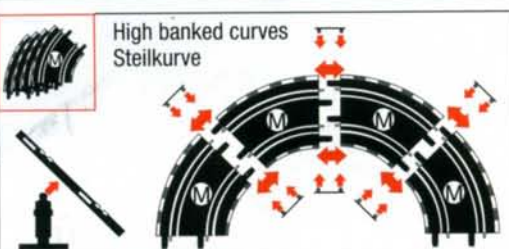
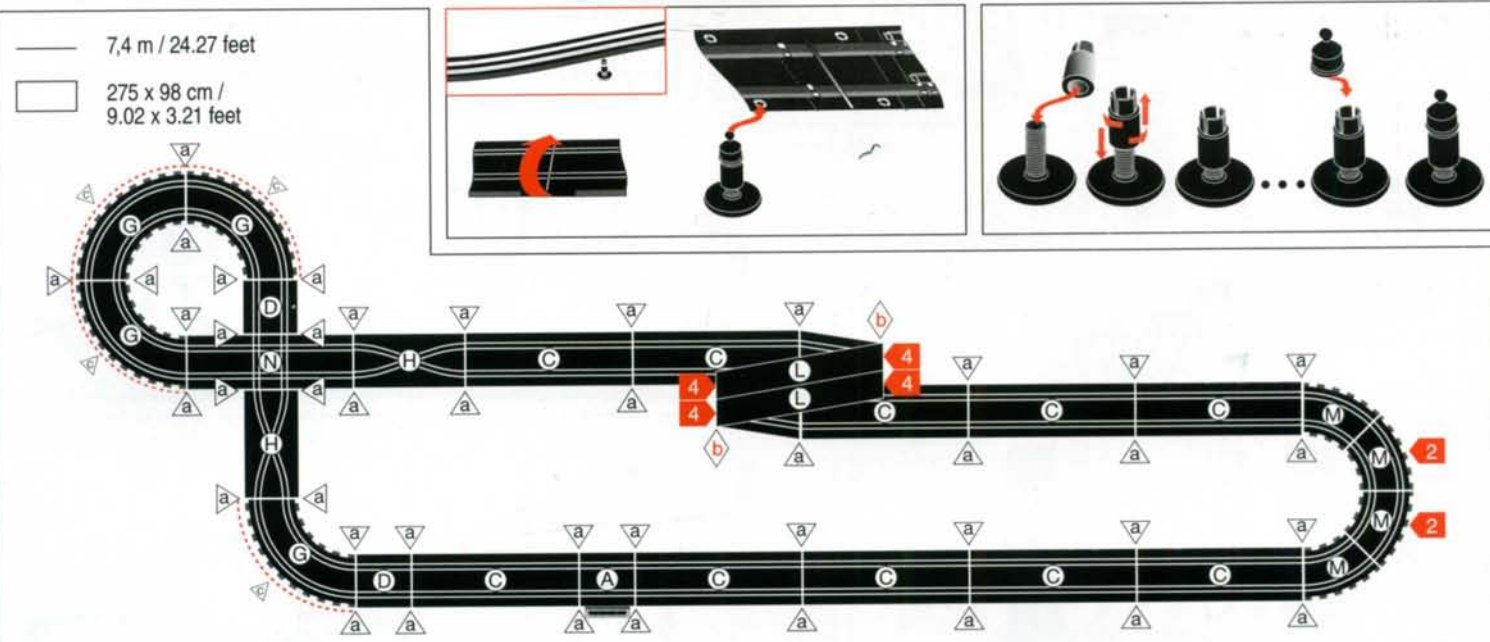
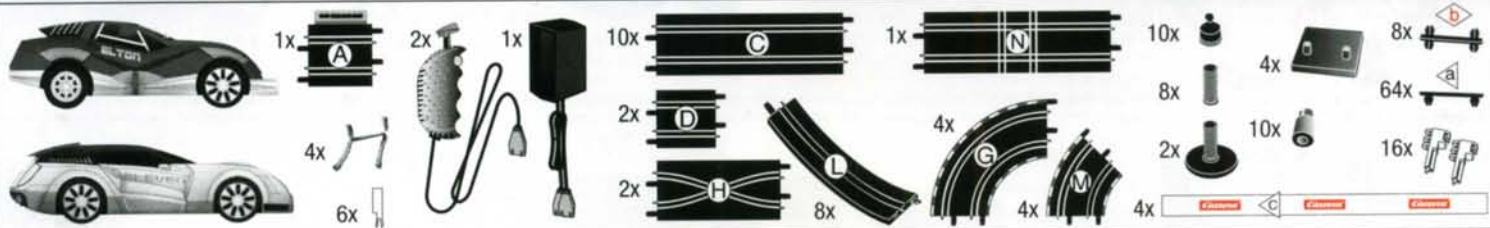

7.60.12.113.00

<p>D Technische und designbedingte Änderungen vorbehalten.</p> <p>GB USA Subject to technical and design-related changes.</p> <p>F Sous réserve de modifications techniques ou de design.</p>	<p>E Se reserva el derecho de efectuar modificaciones técnicas y relacionadas con el diseño.</p> <p>P Reservados os direitos de alterações técnicas e no design.</p> <p>I Con riserva di modifiche tecniche e di design.</p>	<p>PL Zastrzegamy sobie możliwość zmian.</p> <p>NL Technische en designgeboden afwijkingen voorbehouden.</p> <p>S Med reservation för tekniska och designrelaterade ändringar.</p>	<p>FIN Oikeus tekniikan ja muotoilun aiheuttamiin muutoksiin pidätetään.</p> <p>HUN Műszaki és konstrukciós változások előfordulhatnak.</p> <p>GR Επιφύλαξη τεχνικών - σχεδιαστικών τροποποιήσεων.</p>
--	---	---	---

! WARNING: CHOKING HAZARD - Small parts. Not for children under 3 years.

