

- D** Montage und Betriebsanleitung
- GB USA** Assembly and Operating Instructions
- F** Instructions de montage et d'utilisation
- E** Instrucciones de uso y montaje
- P** Instruções de montagem e modo de utilização
- I** Istruzioni di montaggio e d'uso

# Carrera® GO!!!

- PL** Instrukcja obsługi i montażu
- NL** Montage- en gebruiksaanwijzing
- S** Monterings- och bruksanvisning
- FIN** Asennus- ja käyttöohjeet
- HUN** Összeszerelési és használati útmutató
- GR** Μοντάζ και Οδηγία χρήσης

## FORMULA HEROES

Stadlbauer Marketing + Vertrieb Ges.m.b.H. · Magazinstraße 4 · 5027 Salzburg · Austria · [www.carrera-toys.com](http://www.carrera-toys.com) · [www.carreraclub.com](http://www.carreraclub.com)

**62066**

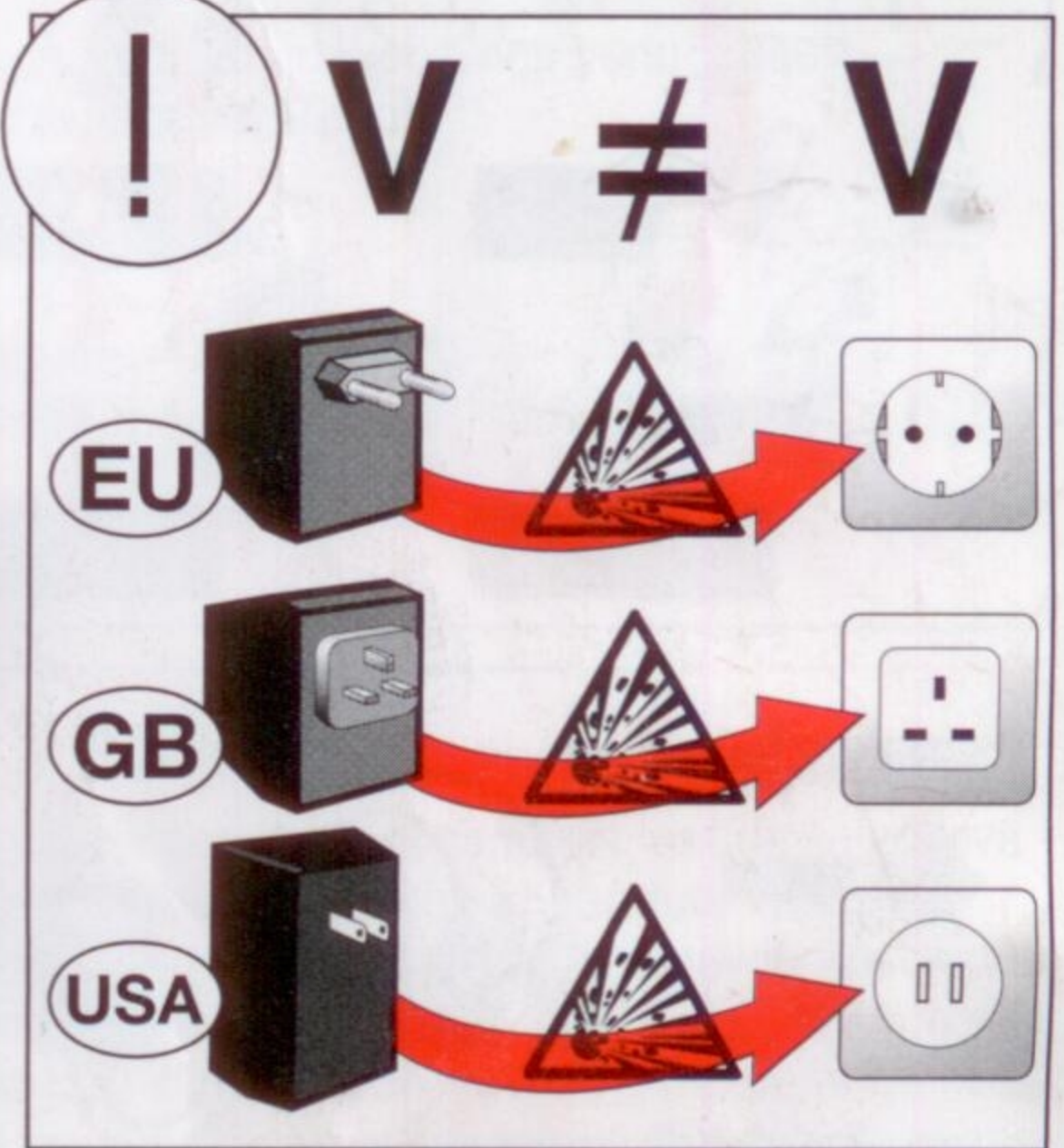
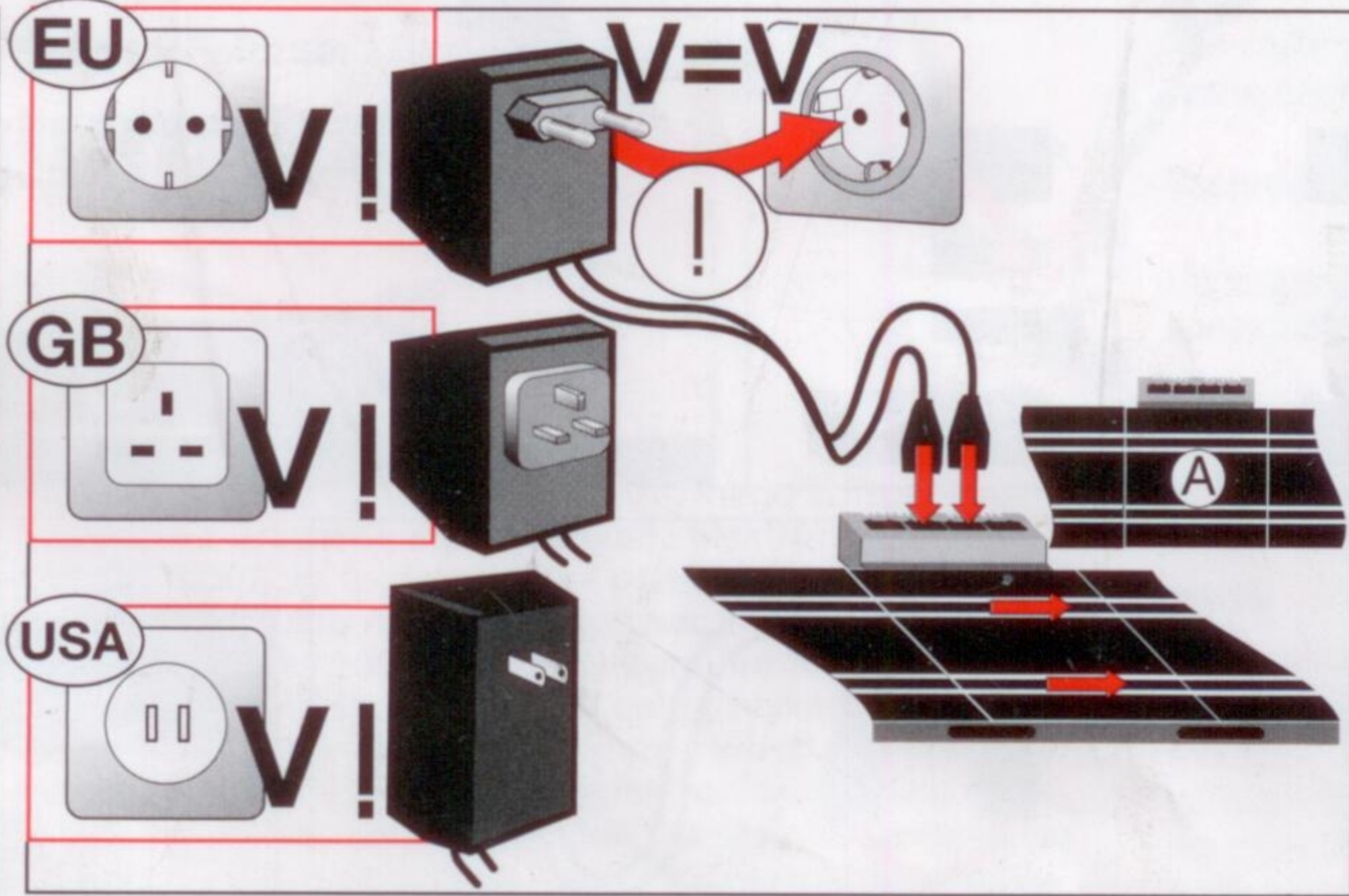
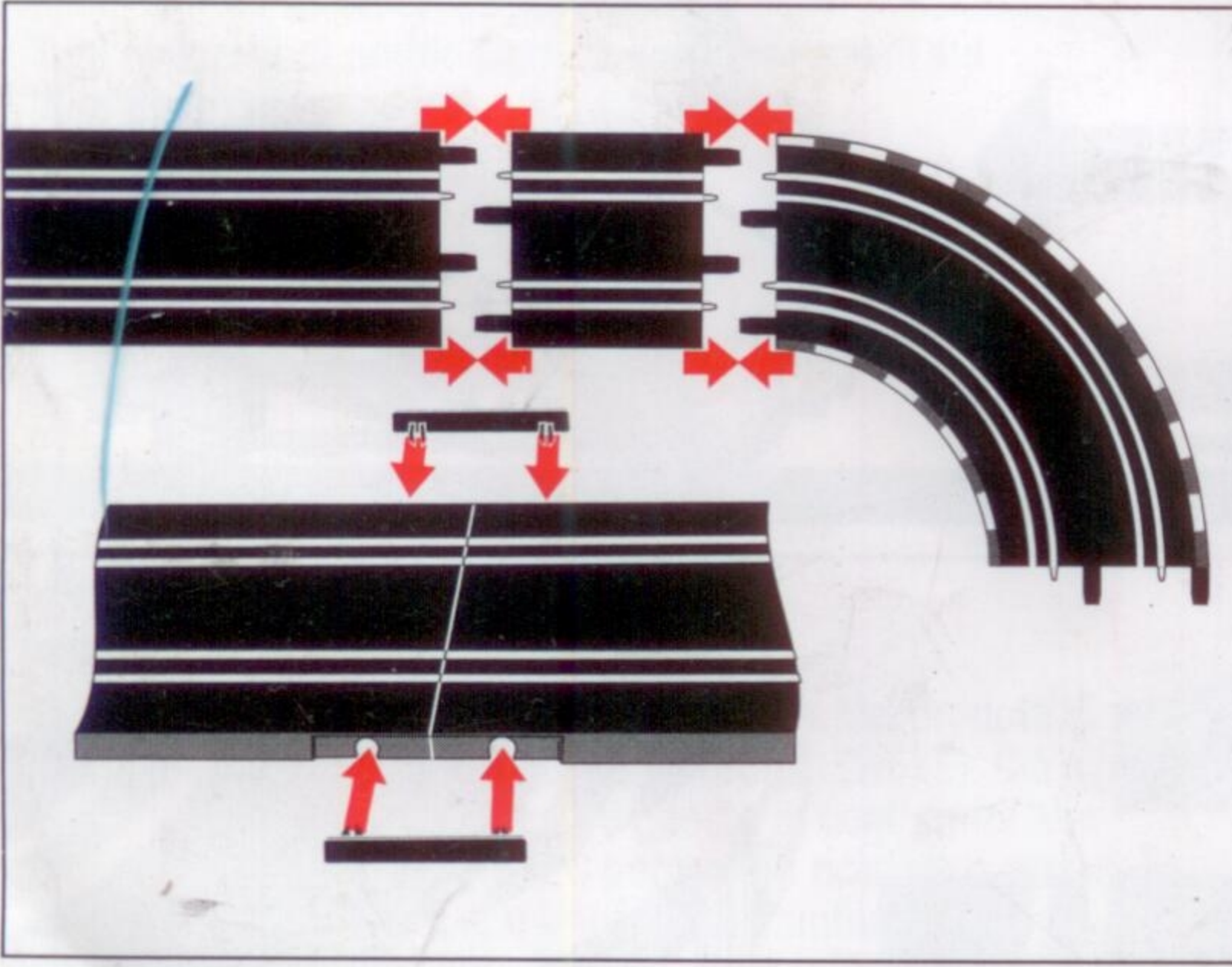
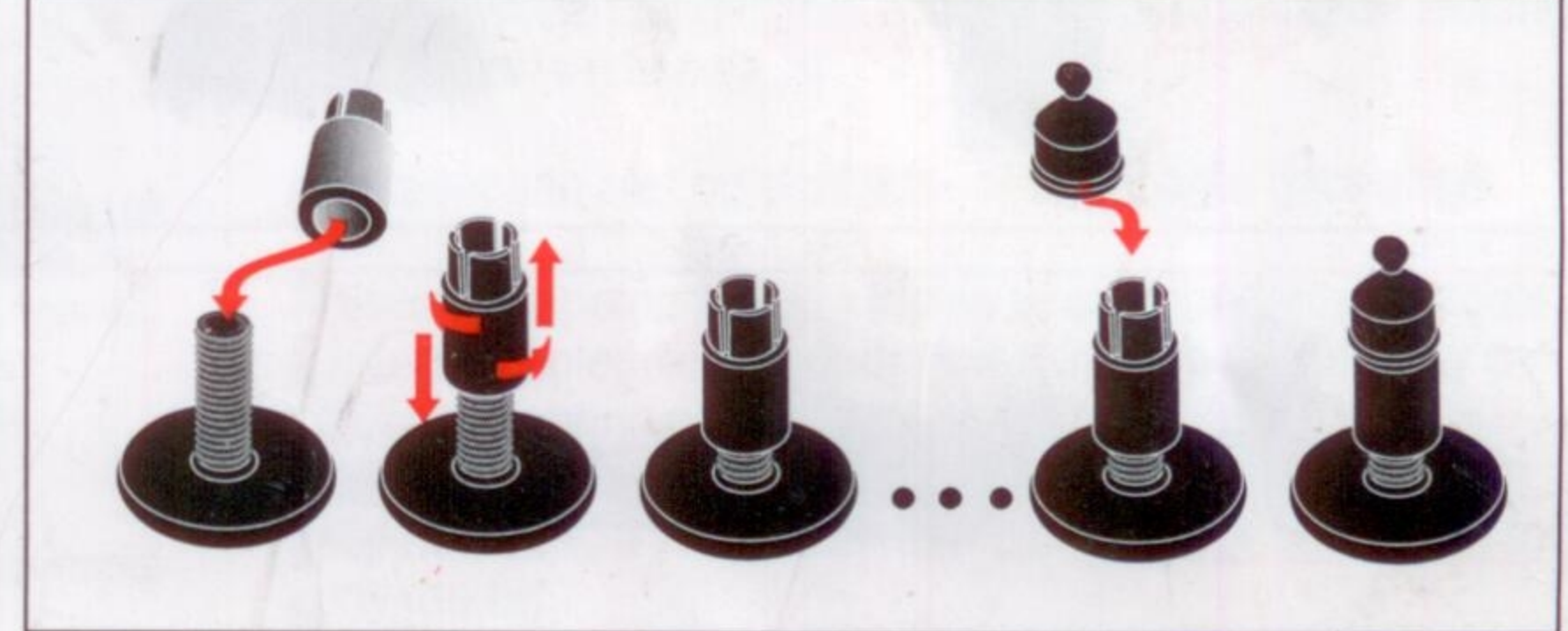
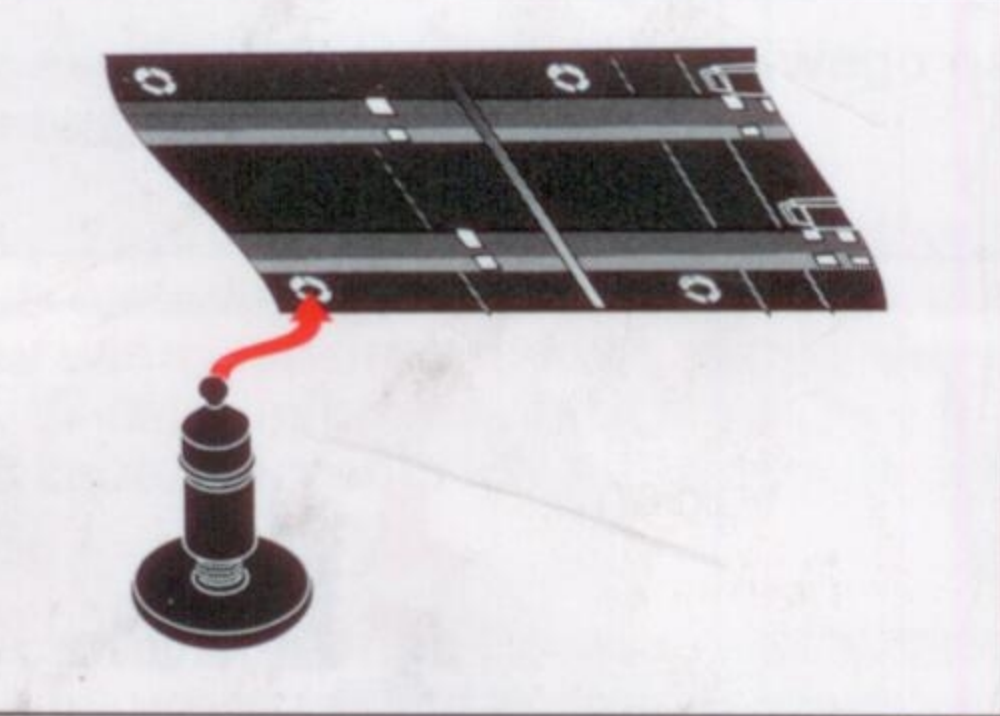
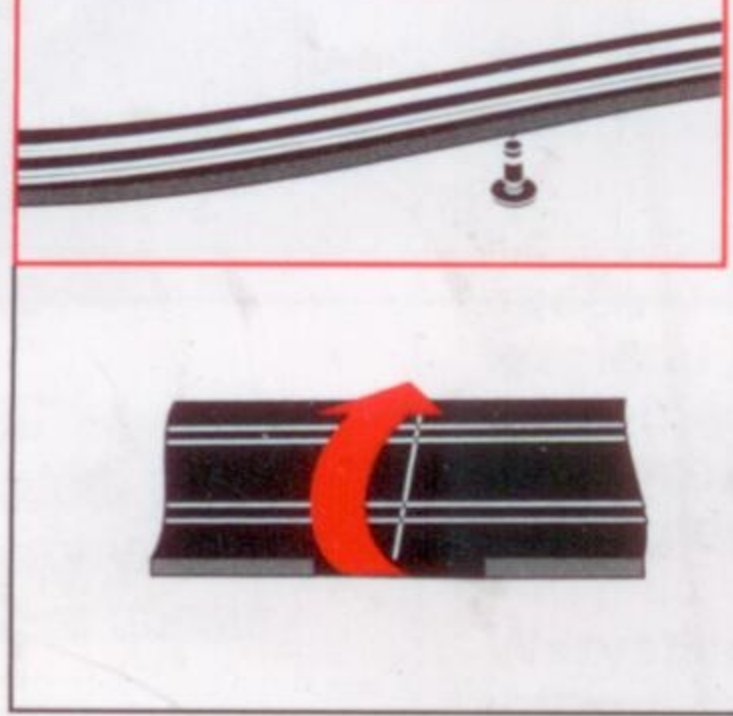
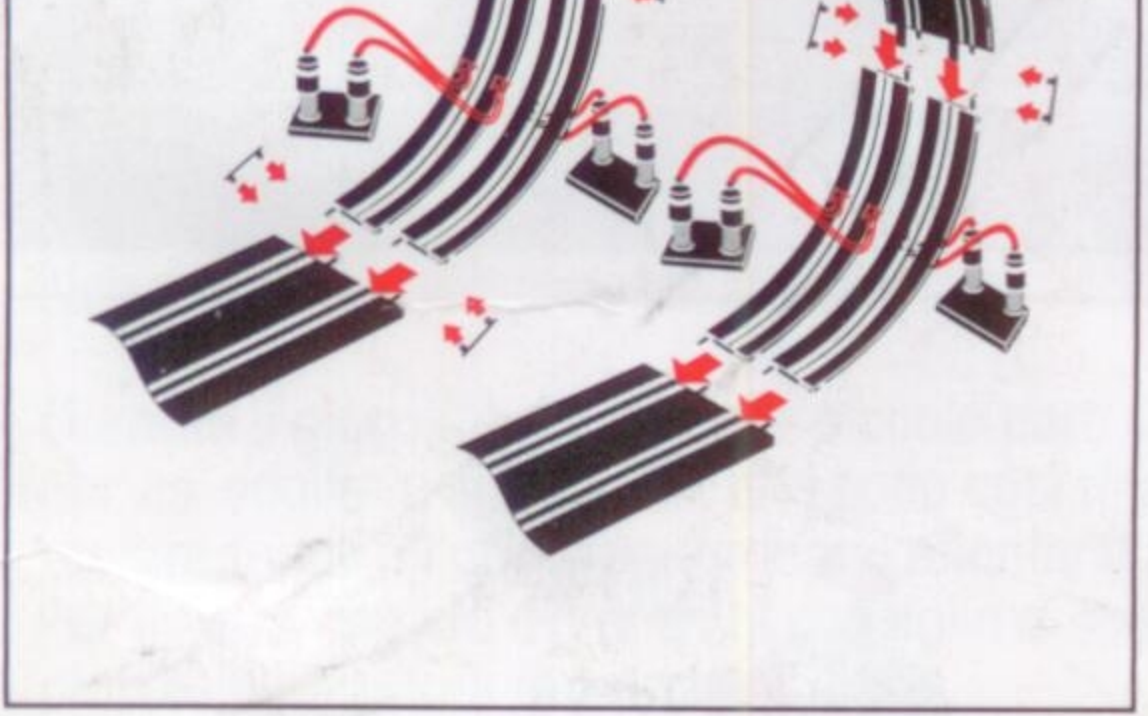
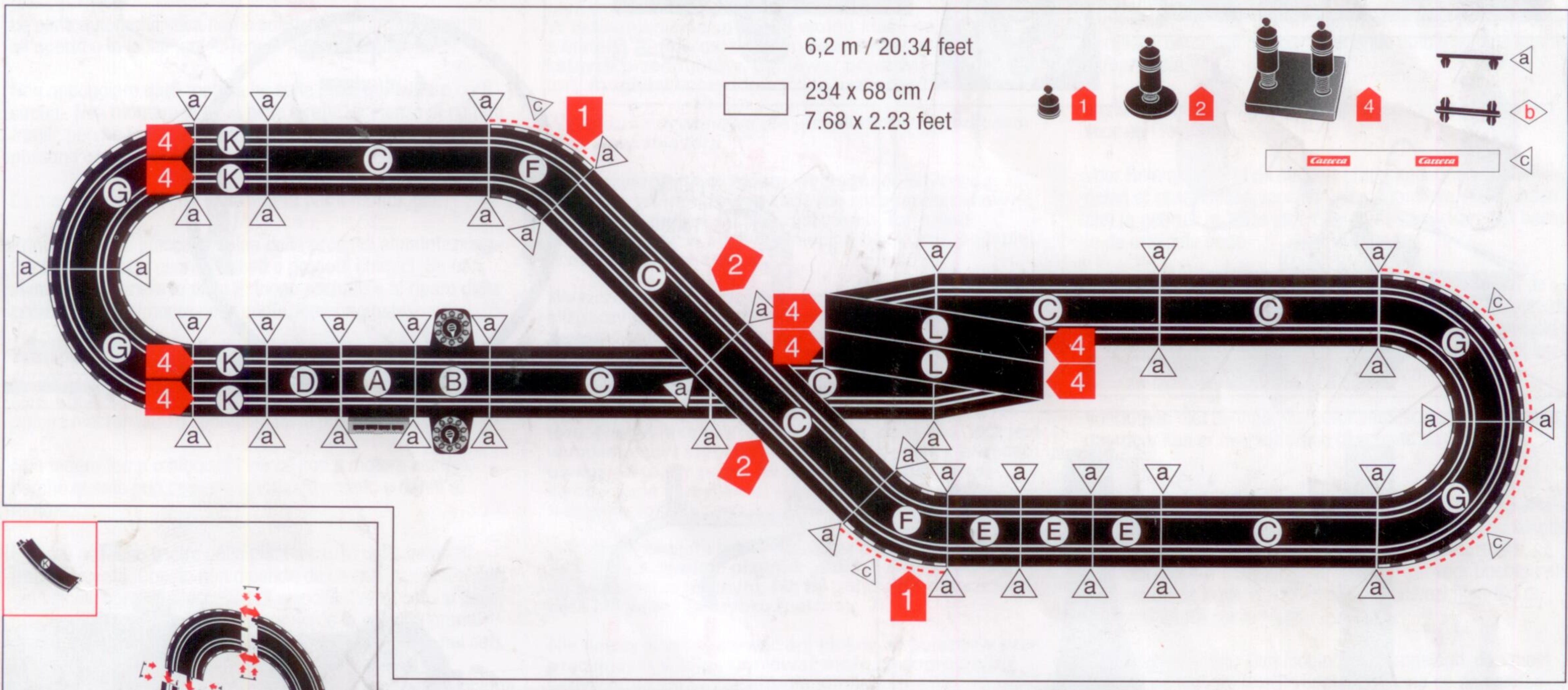
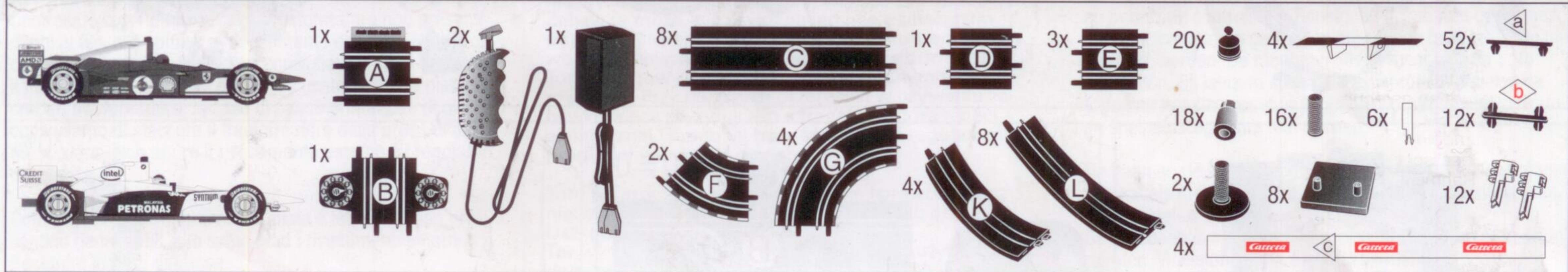

7.60.12.96.00

- |  |   |   |  |
|--|---|---|--|
| <p><b>D</b> Technische und designbedingte Änderungen vorbehalten.</p> <p><b>GB USA</b> Subject to technical and design-related changes.</p> <p><b>F</b> Sous réserve de modifications techniques ou de design.</p> | <p><b>E</b> Se reserva el derecho de efectuar modificaciones técnicas y relacionadas con el diseño.</p> <p><b>P</b> Reservados os direitos de alterações técnicas e no design.</p> <p><b>I</b> Con riserva di modifiche tecniche e di design.</p> | <p><b>PL</b> Zastrzegamy sobie możliwość zmian.</p> <p><b>NL</b> Technische en designgeboden afwijkingen voorbehouden.</p> <p><b>S</b> Med reservation för tekniska och designrelaterade ändringar.</p> | <p><b>FIN</b> Oikeus tekniikan ja muotoilun aiheuttamiin muutoksiin pidätetään.</p> <p><b>HUN</b> Műszaki és konstrukciós változások előfordulhatnak.</p> <p><b>GR</b> Επιφύλαξη τεχνικών - σχεδιαστικών τροποποιήσις.</p> |
|--|---|---|--|

**WARNING:**  
CHOKING HAZARD - Small parts.  
Not for children under 3 years.